

# PSMASPU265P130-X SERIES

## 1-PHASE AC/DC POWER SUPPLY



- High power factor
- Triple output

- 1-phase ac/dc power supply
- Up to 130 w

### Special Features

- Miniature size
- High efficiency
- High power factor (up to 96%)
- Input / Output isolation
- Fixed switching freq. (450 kHz for output converters)
- EMI filters included
- Remote inhibit (On/Off)
- Limited inrush current
- Non-latching protections:
  - Overload/short-circuit
  - Over temperature

### Electrical Specifications

**AC Input** Single-phase 85 to 265 V<sub>AC</sub>  
50/60/400 Hz

**Output Voltage Regulation**  
Less than ±1% (no load to full load, -40 °C to +85 °C at baseplate).

**Ripple and Noise**  
100÷150 mV<sub>p-p</sub>, typical (max. 1%) without external capacitance.

### DC Output

Out #	Option	Voltage Range	Max Current	Max Power
1	A	0.8-12 V	5 A	60 W
	B	0.8-40 V	3.5 A	
2	A	0.8-12 V	5A	60 W
	B	0.8-40 V	3.5 A	
3	A	0.6-5 V	8 A	40 W

Total output power: up to 130 W

**Efficiency**  
83% Typical (at nominal input voltage, full load, room temperature)

**Turn on Transient**  
Voltage overshoot at during power on is less than 3% nominal voltage.

### Isolation

Input to Output: 500 V<sub>DC</sub> Input to Case: 500 V<sub>DC</sub> Output to Case: 100 V<sub>DC</sub> Output to Output: 100 V<sub>DC</sub>

**EMC**  
Designed to meet\* MIL-STD-461F CE102, CS101, CS114, CS115, CS116 RE102, RS103. CE101, RE101 and RS101 optional.

**Input Current Harmonics**  
Meets current harmonics requirements of MIL-STD-1399:300B and EN 61000-3-2 Classes A, B and D.

\* Compliance dependent on specific configuration, and is achieved when using shielded interconnection cable.

## Markets & Applications



Military : airborne, ground-fix, shipboard



Telecom, industrial power supply

## Protections \*

### Input

- **Inrush Current Limiter**  
Peak value of up to 5 times of maximum steady-state input current for inrush currents lasting longer than 50  $\mu$ s.

### Output

- **Overvoltage protection**  
Passive transorbs selected at 120%  $\pm$  10% of nominal voltage.
- **Overload / short-circuit protection**  
Continuous protection (constant current) for unlimited time.

### General

- **Over temperature protection:**  
Shutdown at baseplate temperature of  $+105\text{ }^{\circ}\text{C} \pm 5\text{ }^{\circ}\text{C}$ .  
Automatic recovery when baseplate temperature returns to  $+95\text{ }^{\circ}\text{C} \pm 5\text{ }^{\circ}\text{C}$ .

## Environmental Conditions

Designed to Meet MIL-STD-810F Temperature  
Methods 501.4 & 502.4  
Operating:  $-40\text{ }^{\circ}\text{C}$  to  $+85\text{ }^{\circ}\text{C}$  (at baseplate) Storage:  $-55\text{ }^{\circ}\text{C}$  to  $+125\text{ }^{\circ}\text{C}$  (ambient)

### Altitude

Method 500.4  
Procedures I – up to 70,000 ft. (non-operational)  
Procedure II – up to 40,000 ft. (operational)

### Humidity

Method 507.4  
Up to 95% RH

### Vibration

Method 514.5  
General minimum integrity exposure IAW Figure 514.5C-17  
1 hour per axis.

### Shock

Method 516.5  
20 g, 11 ms terminal peak saw-tooth

### Salt Fog

Method 509.4

## Reliability

100,000 hours, calculated per MIL-STD-217F Notice 2 at  $+85\text{ }^{\circ}\text{C}$  baseplate, Ground Fix conditions.

## Environmental Stress Screening (ESS)

100% of delivered units undergo testing in minimum ambient temperature and maximum baseplate temperature, in addition to testing at room temperature. Additional testing such as random vibration and thermal cycling can be added upon request - **consult factory for details and quote if required.**

---

\* Thresholds and protections can be modified / removed – please consult factory.

*Typical Efficiency*

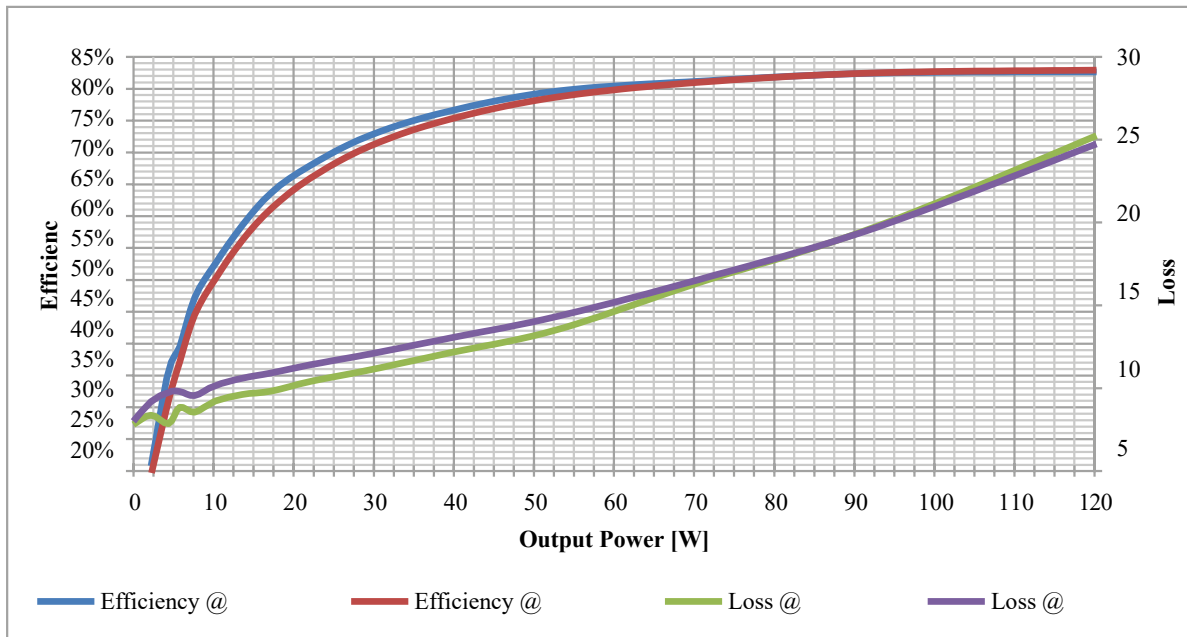

*Typical Power Factor*

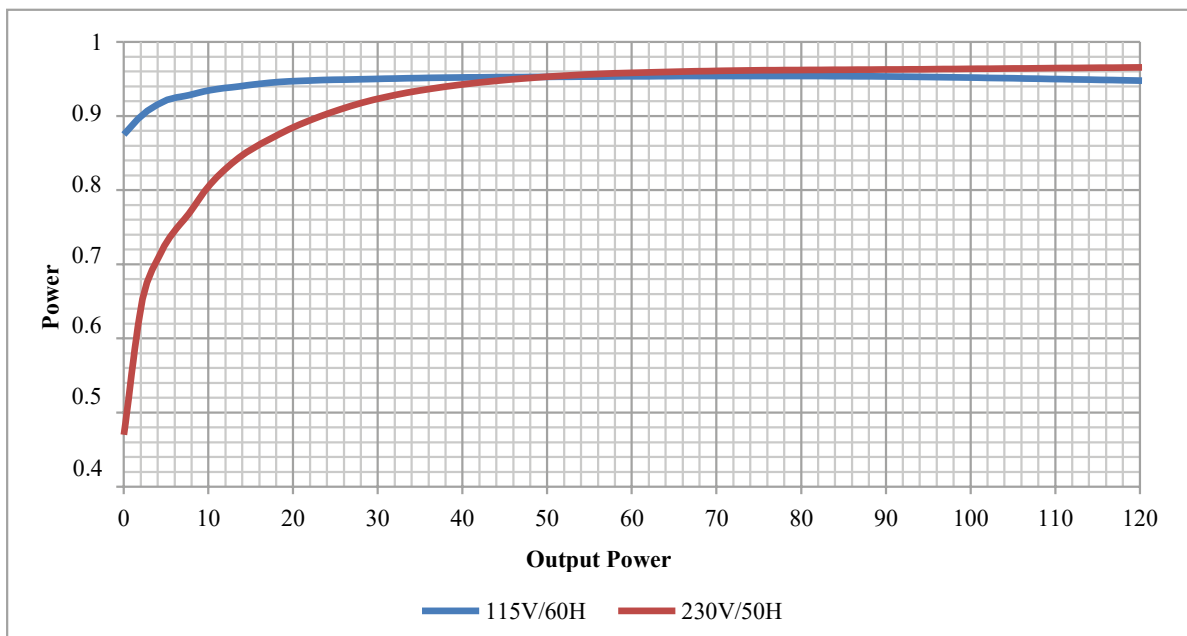

**Test Conditions:**

Input: 115 V<sub>rms</sub>

Outputs: 5 V<sub>DC</sub> / 8 A, +12 V<sub>DC</sub> / 3.5 A, -12 V<sub>DC</sub> / 3.5 A











*Typical test results PWRGOOD Signal*











Resist after 5V source	PWRGOOD Voltage
1 MΩ	31mV
100 KΩ	0.14V
10KΩ	0.36V
1KΩ	1V

## Pin Assignment

Connector type: M24308/24-39F or eq.

Mating connector type: M24308/2-3F or eq.

Pin No.	Function	P	
1	LINE (IN)	~	
2	N/C		
3	N/C		
4	INHIBIT	+	
5	SIGNAL RTN	-	
6	PWR GOOD RTN	-	
7	OUT 3	+	
8	OUT 3 RTN	-	
9	OUT 3 RTN	-	
10	OUT 2	+	
11	OUT 2 RTN	-	
12	OUT 1	+	
13	OUT 1 RTN	-	

Pin No.	Function	P	
14	N/C		
15	NEUTRAL (IN)	0	
16	N/C		
17	SYNC	+	
18	PWR GOOD	+	
19	OUT 3	+	
20	OUT 3	+	
21	OUT 3 RTN	-	
22	OUT 2	+	
23	OUT 2 RTN	-	
24	OUT 1	+	
25	OUT 1 RTN	-	

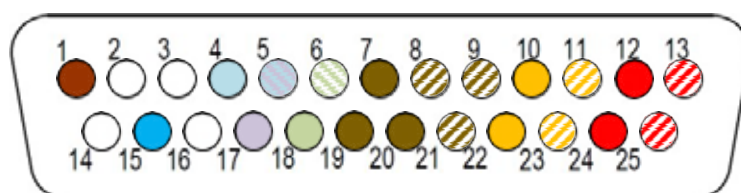

## *Functions and Signals*

### **INHIBIT** (pin 4)

Description: The ***INHIBIT*** signal is used to turn the power supply ON and OFF.

Operation: Applying "1" or leaving open will turn the power supply ON.

Applying "0" or shorting this pin to its return line will turn the power supply OFF. For constant operation, leave this pin unconnected.

Signal Type: 5V TTL or dry contact (open/short).

Return line: This signal is referenced to ***SIGNAL RTN*** (pin 5).

### **SYNC** (pin 17)

Description: The ***SYNC*** signal can be used to allow the power supply switching frequency to synchronize with a system clock.

Operation: Apply a square wave clock with frequency in the range of 450 kHz  $\pm$  10 kHz and duty-cycle of 50%  $\pm$  10%, TTL level.

If not required, leave open. The power supply will work at 450 kHz  $\pm$  10 kHz (internal clock).

Signal Type: 5V TTL

Return line: This signal is referenced to ***SIGNAL RTN*** (pin 5).

### **PWR GOOD** (pin 18)

Description: The ***PWR GOOD*** signal indicates the status of the output voltage.

Operation: When the output voltages rise above 90%  $\pm$  5% of its nominal value, pin 18 will be pulled down to pin 6 through a 100  $\Omega$   $\pm$  1% resistor and three phototransistors.

When one of the output voltages falls below 90%  $\pm$  5% of its nominal value, pin 18 will be in high impedance mode.

If not used, leave the signal unconnected.

This signal is the series connection of three opto-couplers and a 100  $\Omega$  resistor to limit the current.

Signal Type: Isolated open collector.

Return line: This signal is referenced to ***PWR GOOD RTN*** (pin 6) and is floating from all other pins.

**WARNING:** Mind the polarity! Connecting a reverse polarity voltage source with current limit higher than 30mA to this signal will result in permanent damage to the converter.

### **SIGNAL RTN** (pin 5)

Description: Both ***INHIBIT*** and ***SYNC*** signals are referenced to this pin.

## Typical Connection Diagram

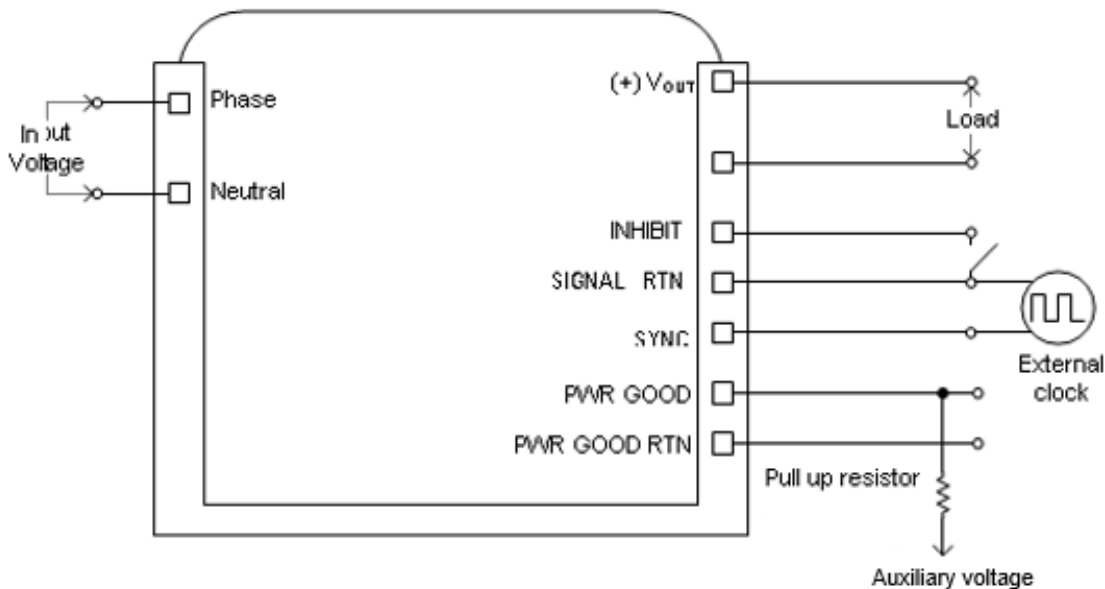

**Note:** PWR GOOD- the load for the pull-up resistor and the auxiliary voltage shown in this diagram should be less than 1mA. The system designer must select the actual values such that no damage can occur to the internal components of the power supply – **consult factory for more information**

## Standard Configurations

Part Number	Input	Output #1		Output #2		Output #3	
		Voltage	Current	Voltage	Current	Voltage	Current
PSMASPU265P130-0	85-260VAC   Single Phase   50/60/400Hz	12 V <sub>DC</sub>	3 A	12 V <sub>DC</sub>	3A	5 V <sub>DC</sub>	8A
PSMASPU265P130-1	85-265VAC   Single Phase   50/60/400Hz	28 V <sub>DC</sub>	2 A	28 V <sub>DC</sub>	2A	3.3 V <sub>DC</sub>	5A
PSMASPU265P130-2	85-265VAC   Single Phase   50/60/400Hz	5 V <sub>DC</sub>	5 A	5 V <sub>DC</sub>	5A	5 V <sub>DC</sub>	8A
PSMASPU265P130-3	85-265VAC   Single Phase   50/60/400Hz	12 V <sub>DC</sub>	5 A	12 V <sub>DC</sub>	5 A	NA	NA

**Note: Specifications are subject to change without prior notice by the manufacturer.**

# PSMASPU265P130-X SERIES

## Outline Drawing

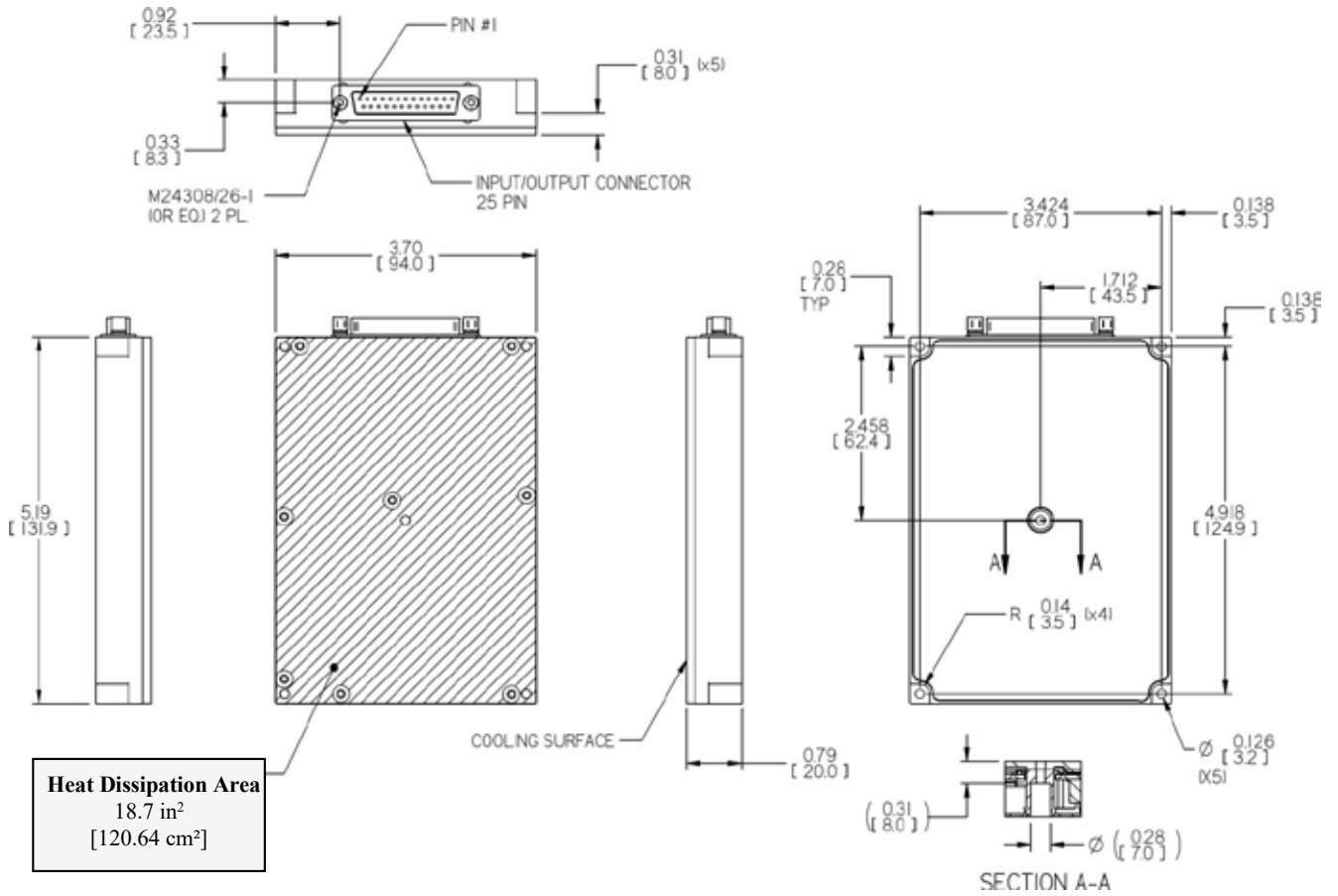

## Notes

1. Dimensions are in inches [mm]
2. Tolerance is:  
.XX ± .02 in  
.XXX ± .010 in
3. Weight: approx. 14.46 oz [410 g]

**Note: Specifications are subject to change without prior notice by the manufacturer.**

# PSMASPU265P130-X SERIES

## Label position

